



OPTO ENGINEERING

# ILLUMINATOR DATA

## LT5WRG200-00-1-RGBW-24V

Lighting Dimension

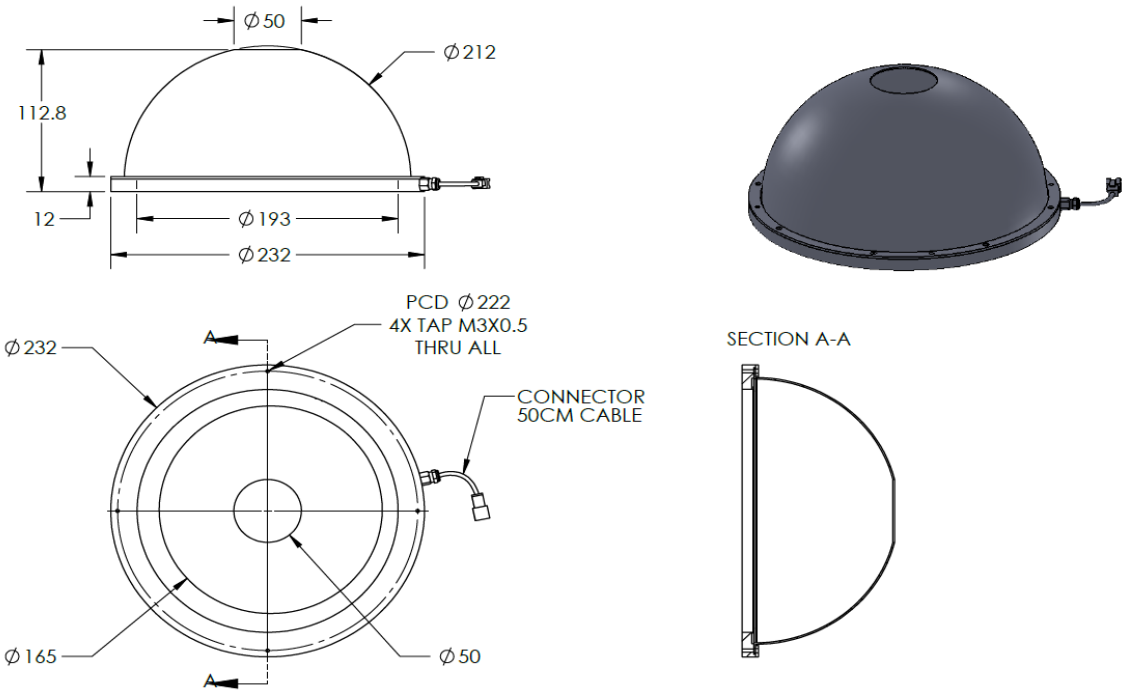

Mechanical Information	
Casing Material	Aluminium
Storage Temperature Range	0 - 45°C
Storage Humidity Range	20 - 85%
Weight	520 g
Length / Outer Diameter	232 mm
Width / Inner Diameter	50 mm
Thickness / Height	112.8 mm

# ILLUMINATOR DATA

## LT5WRG200-00-1-RGBW-24V

Lighting Information													
Part Number	LT5WRG200-00-1-RGBW-24V												
LED Color	RED			GREEN			BLUE			WHITE			
Wavelength	630 nm			525 nm			470 nm			refer to chromaticity table			
Working Distance	50 mm	60 mm	80 mm	50 mm	60 mm	80 mm	50 mm	60 mm	80 mm	50 mm	60 mm	80 mm	
Intensity (±15%)	2210 lx	2000 lx	1620 lx	5900 lx	5330 lx	4330 lx	6170 lx	5580 lx	4570 lx	4950 lx	4480 lx	3640 lx	
Illumination (number of row)	1												
Illumination Active Area	Active Length / Outer Dia.			193 mm									
	Active Width / Inner Dia.			50 mm									
Emission angle	0												
Eye Safety Class ( IEC62471 )	EXEMPT			EXEMPT			II			EXEMPT			
Chromaticity Table For White colour only				X	0.296	0.287	0.307	0.311	X	0.311	0.307	0.33	0.33
				Y	0.276	0.295	0.315	0.294	Y	0.294	0.315	0.339	0.318

Electrical Information				
Rated Constant Voltage	24V±2%			
Rated Constant Current	270 mA	270 mA	270 mA	270 mA
Power Consumption	6.48 W	6.48 W	6.48 W	6.48 W
Casing temperature, After 60 minutes operation	42.3 °C			
Max. continuous current of RED, GREEN & BLUE LEDs on at the same time	*It is not recommended to turn on Red, Green and Blue colour at the same time. Refer to Maximum Simultaneous Current Output section in the last page for maximum current that can be supplied for each colour. Failure in following this may results in damaging the lighting.			

Strobe Mode Specification				
**Normal Strobe Voltage	24 V			
**Normal Strobe Current	270 mA	270 mA	270 mA	270 mA
Overdrive Voltage Range	Min: 36 V Max: 48 V	Min: 36 V Max: 48 V	Min: 36 V Max: 48 V	Min: 36 V Max: 48 V
Overdrive Current Range	Min: 0.42 A Max: 0.69 A	Min: 0.49 A Max: 0.82 A	Min: 0.54 A Max: 0.90 A	Min: 0.74 A Max: 1.23 A
Max. pulse current of RED, GREEN & BLUE LEDs on at the same time	*It is not recommended to turn on Red, Green and Blue colour at the same time. Refer to Maximum Simultaneous Current Output section in the last page for maximum current that can be supplied for each colour. Failure in following this may results in damaging the lighting.			
Recommended Overdrive Voltage	36V			
***Max. Trigger Pulse Duration	10 msec			
***Max. Duty Cycle	10%			

\*\*Normal strobe means the lighting is operated using the rated power. Overdrive means the power supplied to the lighting exceeded the rated power.

\*\*\*Overdrive condition must not exceed the max. trigger pulse duration and max. duty cycle. Failure in following this may results in damaging the lighting.

# ILLUMINATOR DATA

## LT5WRG200-00-1-RGBW-24V

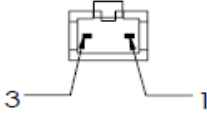









Connection Information			
Connector Type (Default)	JST SMR-03V		
Cable Length	50 cm		
Pin Configuration 	Pin	Signal	Cable Colour
	1	LED +	Red
	2	N.C	-
	3	LED -	White
			

Additional Information	
Additional Cooling Method	Attached to machine part for better heat dissipation
Intensity Controller Selection	SD, ST, ANG, LC, SDA, SDP series
CE Conformity	YES
RoHS Compliance	YES

Application	
Illumination Type	Indirect Dome Illumination
Application Use	Cracks, Chips, Stains & Marks on Circular or Cylindrical Object Inspection, Solder and Substrate Inspection

# ILLUMINATOR DATA

## LT5WRG200-00-1-RGBW-24V

Maximum Simultaneous Current Output Information		
Colour	Current Limit (A)	Remarks
 SINGLE COLOUR : RED	0.27 A	TOTAL CURRENT OUTPUT : 0.27 A RECOMMENDED OVERDRIVE CURRENT : 0.74 A (36 V) ** OPTIMUM FOR SINGLE COLOUR
 SINGLE COLOUR : GREEN	0.27 A	TOTAL CURRENT OUTPUT : 0.27 A RECOMMENDED OVERDRIVE CURRENT : 0.74 A (36 V) ** OPTIMUM FOR SINGLE COLOUR
 SINGLE COLOUR : BLUE	0.27 A	TOTAL CURRENT OUTPUT : 0.27 A RECOMMENDED OVERDRIVE CURRENT : 0.74 A (36 V) ** OPTIMUM FOR SINGLE COLOUR
 COMBINE 2 COLOUR: RED & BLUE	0.27 A	TOTAL CURRENT OUTPUT : 0.27 A ****[EXAMPLE : RED = 0.14 A , BLUE = 0.14 A] *****(OVERDRIVE STROBE MODE EXAMPLE : RED = 0.37 A , BLUE = 0.37 A) FOR COMBINE COLOUR TEMPERATURE CANNOT EXCEED MORE THAN 60°C ENSURE CURRENT MUST NOT EXCEED 0.5 A 
 COMBINE 2 COLOUR: RED & GREEN	0.27 A	TOTAL CURRENT OUTPUT : 0.27 A ****[EXAMPLE : RED = 0.14 A , GREEN = 0.14 A] *****(OVERDRIVE STROBE MODE EXAMPLE : RED = 0.37 A , GREEN = 0.37 A) FOR COMBINE COLOUR TEMPERATURE CANNOT EXCEED MORE THAN 60°C ENSURE CURRENT MUST NOT EXCEED 0.5 A 
 COMBINE 2 COLOUR: GREEN & BLUE	0.27 A	TOTAL CURRENT OUTPUT : 0.27 A ****[EXAMPLE : GREEN = 0.14 A , BLUE = 0.14 A] *****(OVERDRIVE STROBE MODE EXAMPLE : GREEN = 0.37 A , BLUE = 0.37 A) FOR COMBINE COLOUR TEMPERATURE CANNOT EXCEED MORE THAN 60°C ENSURE CURRENT MUST NOT EXCEED 0.5 A 
 COMBINE COLOUR: RED, GREEN & BLUE	0.27 A	TOTAL CURRENT OUTPUT : 0.27 A ****[EXAMPLE : RED = 0.08 A , GREEN = 0.08 A , BLUE = 0.08 A] *****(OVERDRIVE STROBE MODE EXAMPLE : RED = 0.25 A , GREEN = 0.25 A , BLUE = 0.25 A) FOR COMBINE COLOUR TEMPERATURE CANNOT EXCEED MORE THAN 60°C ENSURE CURRENT MUST NOT EXCEED 0.5 A 



# ILLUMINATOR DATA

**LT5WRG200-00-1-RGBW-24V**

Lighting Pattern																																											
Working Distance	For further details please contact us.																																										
Display and Image																																											
Data Results	<table border="1"> <thead> <tr> <th>Horizontal</th> <th>Meas.(mm)</th> </tr> </thead> <tbody> <tr><td>90%</td><td></td></tr> <tr><td>80%</td><td></td></tr> <tr><td>70%</td><td></td></tr> <tr><td>60%</td><td></td></tr> <tr><td>50%</td><td></td></tr> <tr><td>40%</td><td></td></tr> <tr><td>30%</td><td></td></tr> <tr><td>20%</td><td></td></tr> <tr><td>10%</td><td></td></tr> </tbody> </table>	Horizontal	Meas.(mm)	90%		80%		70%		60%		50%		40%		30%		20%		10%		<table border="1"> <thead> <tr> <th>Vertical</th> <th>Meas.(mm)</th> </tr> </thead> <tbody> <tr><td>90%</td><td></td></tr> <tr><td>80%</td><td></td></tr> <tr><td>70%</td><td></td></tr> <tr><td>60%</td><td></td></tr> <tr><td>50%</td><td></td></tr> <tr><td>40%</td><td></td></tr> <tr><td>30%</td><td></td></tr> <tr><td>20%</td><td></td></tr> <tr><td>10%</td><td></td></tr> </tbody> </table>	Vertical	Meas.(mm)	90%		80%		70%		60%		50%		40%		30%		20%		10%		
Horizontal	Meas.(mm)																																										
90%																																											
80%																																											
70%																																											
60%																																											
50%																																											
40%																																											
30%																																											
20%																																											
10%																																											
Vertical	Meas.(mm)																																										
90%																																											
80%																																											
70%																																											
60%																																											
50%																																											
40%																																											
30%																																											
20%																																											
10%																																											